

16  
**stuv**

## Stûv 16-in inserts | inbouwhaarden



16/58 <b>A</b>	16/68 <b>A</b>	16/78 <b>A</b>
2 473€	2 764€	2 979€

cadre de finition inclus | afwerkingskader inbegrepen

## Stûv 16-in cadres | kaders

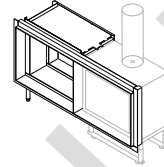

D4 Déco gauchou droite  
D4 Deco links of rechts

16/58	1 406€
16/68	1 406€
16/78	1 406€

## Stûv 16-cheminée inserts | inbouwhaarden



16/58 <b>A</b>	16/68 <b>A</b>	16/78 <b>A</b>
3 373€	3 739€	3 982€

version cheminée blanche | met witte schoorsteenmantel

## Stûv 16-up poêles | kachels



16/58 <b>A</b>	16/68 <b>A</b>	16/78 <b>A</b>
3 122€	3 309€	3 576€

## Stûv 16-H poêles | kachels



16/58 <b>A</b>	16/68 <b>A</b>	16/78 <b>A</b>
3 429€	3 645€	3 934€

## Stûv 16-H accessoires | accessoires





plaque de sol  
vloerplaat



16/58	105€
16/68	116€
16/78	126€

16  
**stûv**

## Stûv 16-cube poêles | kachels

		
16/58 A	16/68 A	16/78 A
2 992€	3 186€	3 459€

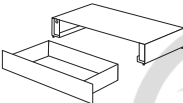
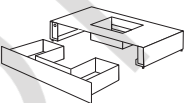
## Stûv 16-cube socles | sokkels

			
socle + tiroir 60 cm sokkel 60 cm + lade	socle + tiroir 120 cm sokkel 120 cm + lade	socle + tiroir en U sokkel 120 cm + lade in U-vorm	chariot à bûches + tiroir houtblokkenkarretje + lade
655€	914€	914€	886€

finition: 20 couleurs disponibles | afwerking: 20 beschikbare kleuren

## Stuv 6-in inserts | inbouwhaarden



6-IN 46X55  
A

2 275€



6-IN 56X50  
A

2 381€



6-IN 66X50  
A

2 485€



6-IN 66X55  
A

2 561€



6-IN 76X55  
A

2 635€

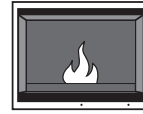

6-IN 76X60  
A

2 763€



6-IN 86X60  
A

2 889€

cadre fin et sortie de fumée oblique inclus | fijne afwerkingskader en 45° rookuitlaat inbegrepen

## Stuv 6-in accessoires | accessoires

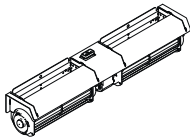

ventilateur  
ventilator

390€

## Stuv 6-H poêles | kachels



6-H 60x65 A

2 838€\*



6-H 70x73 A

3 045€\*



6-H 80x80 A

3 220€\*

3 333€\*\*

3 529€\*\*

\* plaque acier et sortie de fumées verticale incluse | plaat in staal en rookafvoer inbegrepen

\*\* plaque fonte et sortie de fumées verticale incluse | gietijzeren plaat en rookafvoer inbegrepen

## Stuv 6-H accessoires | accessoires

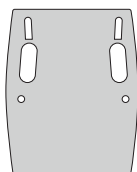

plaque de sol  
vloerplaat

6-H 60x65

152€

6-H 70x73

184€

6-H 80x80

194€

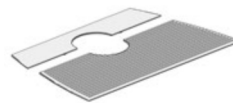

plaque de chauffe (option)  
cook top (optie)

6-H 60x65

-





6-H 70x73



326€

6-H 80x80

347€

## Stuv 21 inserts simple-face | enkelzijdiginbouwhaarden



	 21/65H A	 21/75 A	 21/85 A	 21/95 A
A	3 422€	3 399€	3 851€	4 208€
B	3 502€	3 476€	3 922€	4 287€

	 21/105 A	 21/125 A
A	-	5 161€
B	4 000€	5 277€

A = relevé partiel comprend le couvercle, la sortie de fumée basse et 4 buselots  
**gedeeltelijke deuropening bevat het deksel, de lage rookuitgang en 4 aansluitstukken**

B = relevé total comprend la hausse, la sortie de fumée haute et 4 buselots  
**volledige deuropening bevat de verhogingselement, de hoge rookuitgang en 4 aansluitstukken**  
 arrivée d'air extérieur directe en option | **rechtstreekseinlaat voor buitenlucht in optie**

## Stuv 21 inserts double-face | dubbelzijdiginbouwhaarden

	 21/75 A	 21/85 A	 21/95 A
A	4 553€	4 973€	5 416€
B	4 630€	5 044€	5 495€

A = relevé partiel | **gedeeltelijke deuropening**

B = relevé total | **volledige deuropening**

## Stuv 21 cadres | kaders

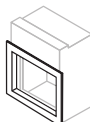
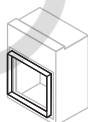

	cadre fin   <b>fijn kader</b>	cadre à appliquer   <b>opbouw kader</b>
21/65H	228€	350€
21/75	230€	368€
21/85	246€	386€
21/95	257€	406€
21/105	252€	401€
21/125	284€	484€

foyer non compris | **haard niet inbegrepen**

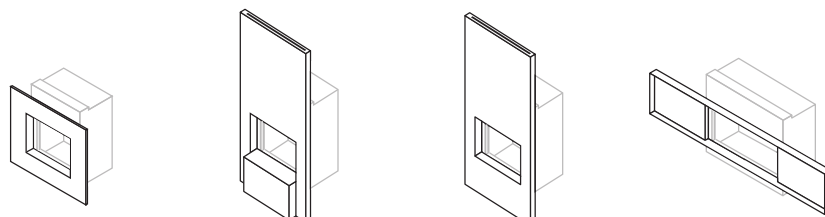
**Stûv 21** devantures | frontpanelen

	SF4	SF5	SF6	SF8
21/65H	662€	-	1 170€	-
21/75	625€	1 605€	1 529€	-
21/85	662€	1 751€	1 675€	-
21/95	717€	1 898€	1 828€	-
21/105	680€	1 751€	-	821€
21/125	779€	2 189€	2 043€	-

 foyer non compris | **haard niet inbegrepen**

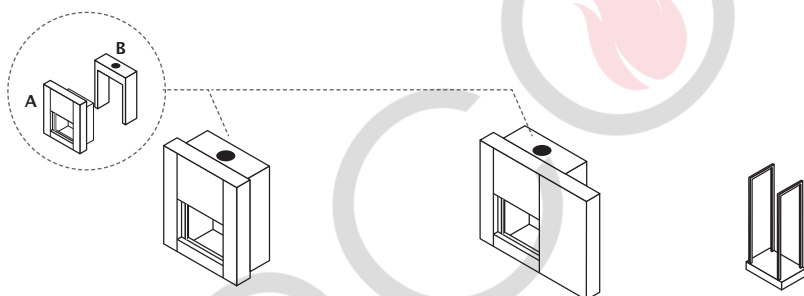
 dimensions sur mesure: contactez votre revendeur | **afmetingen op maat: contacteer uw verdeler**
**Stûv 21** cheminées à poser - modèles simple-face | plaatsklareschouwen - enkelzijdig modellen

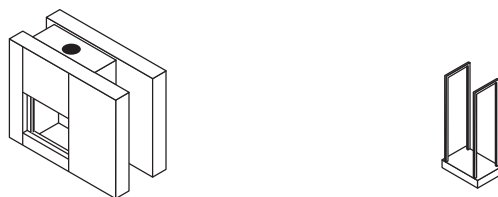

	SF1		SF2		rack à bûches houtblokkenrek
	A	B	A	B	
21/75	1 235€	312€	1 359€	312€	431€
21/85	1 359€	334€	1 482€	334€	431€
21/95	1 482€	371€	1 605€	371€	431€
21/105	-	-	1 482€	334€	431€
21/125	1 605€	400€	1 728€	400€	431€

 finition: 20 couleurs disponibles (sauf parties B) | **afwerking: 20 beschikbare kleuren (behalve delen B)**
**Stûv 21** cheminées à poser - modèles double-face | plaatsklareschouwen - dubbelzijdig modellen

	DF2	rack à bûches   houtblokkenrek
21/75	3 028€	431€
21/85	3 275€	431€
21/95	3 582€	431€

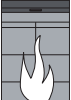

 finition: 20 couleurs disponibles | **afwerking: 20 beschikbare kleuren**

Stuv 22 inserts simple-face | enkelzijdiginbouwhaarden

		
<b>22/70 A+</b>	<b>22/90 A+</b>	<b>22/110 A+</b>
4 386€	4 678€	4 678€

intérieur clair ou foncé au choix | heldere of donkere stenen

Stuv 22 inserts double-face | dubbelzijdiginbouwhaarden

	
<b>22/90 DF A+</b>	<b>22/110 DF A+</b>
6 160€	6 160€

uniquement intérieur foncé | enkel beschikbaar met donkere stenen

Stuv 22 cadres | kaders

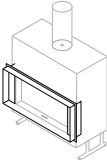
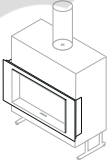
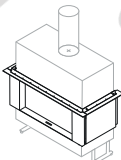
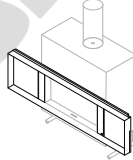
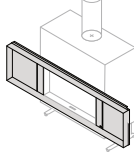
						
	S4	A4 Verre   Glas	A4 Rouille   Geroest	C2	L4	L4 à gamir L4 te personaliseren
22/70	362€	666€	525€	546€	-	-
22/90	362€	688€	548€	546€	1 145€	1 004€
22/110	362€	688€	548€	546€	1 145€	1 004€

A4 Verre: disponible en blanc brillant, noir mat, moka mat | A4 Glas: beschikbaar in White Brillant, Moka Mat, Black Mat

A4 Rouille en 2mm d'épaisseur | A4 Geroest 2 mm dikte

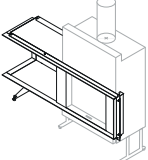
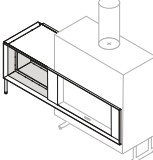
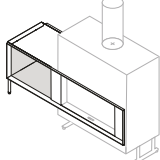
				
		D3 gauche ou droite D3 links of rechts	D4 Bûches gauche ou droite D4 Hout links of rechts	D4 Déco gauche ou droite D4 Deco links of rechts
Simple face Enkelzijdig	22/70	1 615€	1 504€	1 437€
	22/90	1 615€	1 504€	1 437€
	22/110	1 615€	1 504€	1 437€
Double face Dubbelzijdig	22/90	-	2 060€	1 994€
	22/110	-	2 060€	1 994€

Stûv 22 structure à garnir | structuurromte bekleden

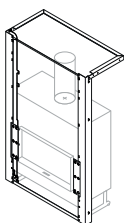

22/70	700€
22/90	700€
22/110	700€

Stûv 22 devantures | frontpanelen

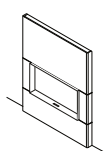

DS

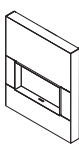

SF1

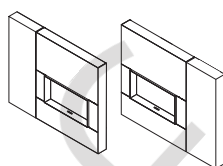

SF2 gauche ou droite  
SF2 links of rechts

22/70	1 622€	-	-
22/90	1 622€	1 239€	1 526€
22/110	1 622€	1 239€	1 526€

Stûv 22 cheminées à poser | plaatsklareschouwen

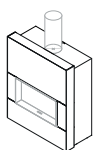

SF1

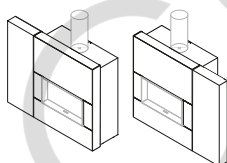

SF2 gauche ou droite  
SF2 links of rechts

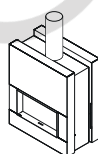

DF1

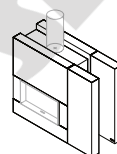

DF2

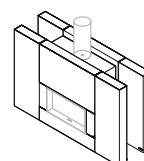

DF7

22/70	-	-	-	-	-
22/90	1 574€	1 860€	3 085€	4 113€	5 141€
22/110	1 574€	1 860€	3 085€	4 113€	5 141€

Stûv 22 accessoires | accessoires



chariot à bûches DarkGrey  
houtblokkenkarretje DarkGrey  
50 × 34 × 129

356€
------

Stûv30 A*	Stûv30 H A*	Stûv30 H A* avec accumulateur met accumulator	Stûv30-up (a) A*	Stûv30-in A*	Stûv30-in R A*
4 742€ <sup>(1)</sup>	5 429€ <sup>(1)</sup>	5 971€ <sup>(1)</sup>	4 711€ <sup>(a1)</sup>	4 962€ <sup>(a4)</sup>	5 200€
4 941€ <sup>(2)</sup>	5 620€ <sup>(2)</sup>	6 162€ <sup>(2)</sup>	5 331€ <sup>(a2)</sup>	4 781€ <sup>(a5)</sup>	
4 817€ <sup>(3)</sup>	5 526€ <sup>(3)</sup>	6 068€ <sup>(3)</sup>			

- (1) avec sortie de fumées haute fixe | met verticale vaste rookuitgang  
 (2) avec sortie de fumées haute rotative | met verticale draaibare rookuitgang  
 (3) avec sortie de fumées arrière | met horizontale rookuitgang  
 (4) version Stûv 30-inB | versie Stûv 30-in B  
 (5) version pour devanture et cheminées à poser Stûv | versie voor frontpanelen en plaatsklare schouwen Stûv  
 (a) colonne de convection de 1m48<sup>(a1)</sup> ou 2m90<sup>(a2)</sup> incluse | convectiekolom van 1m48<sup>(a1)</sup> of 2m90<sup>(a2)</sup> inbegrepen

Stûv 30 plaque de sol | vloerplaat

	ronde ronde	ovoidale ovale
Stûv Grey	230€	230€

Stûv 30-in devantures & cheminées à poser | frontpanelen & plaatsklare schouwen

modèle étroit small model		modèle large brede model		modèles asymétriques asymmetrische modellen		cheminée de coin hoekschouw	chariot à bûches houtblokkenkarretje	plaque de sol vloerplaat
A	B	A	B	A	B		50 × 34 × 129 Stûv Grey	Stûv Grey
843€	1 114€	1 107€	1 763€	975€	1 554€	1 066€	331€	132€

A = devanture | frontpaneel - B = cheminée à poser | plaatsklare schouw  
 finition: devantures disponibles en 20 couleurs | afwerking: frontpanelen beschikbaar in 20 kleuren  
 foyer non compris | haard niet inbegrepen

(1) armoire à bûches 180cm comprise | houtenkast 180cm inbegrepen



# stûv 30-compact

Stûv30-compact A*	Stûv30-compact one A*	Stûv30-compact H A*	Stûv30-compact H avec accumulateur met accumulator A*	Stûv30-compact in A*	Stûv30-compact in R A*
4089€ <sup>(1)</sup>	3 031€	4 541€	5 036€	4 659€ <sup>(2)</sup> 4 474€ <sup>(3)</sup>	4 785€

(1) disponible en StûvGrey et StûvBlack | beschikbaar in StûvGrey en StûvBlack

(2) version Stûv 30-compact in B | versie Stûv 30-compact in B

(3) version pour devanture et cheminées à poser Stûv | versie voor frontpanelen en plaatsklare schouwen Stûv

## Stûv 30-compact plaque de sol | vloerplaat

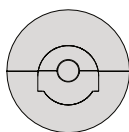

ronde  
ronde

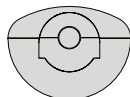

ovoidale  
ovale

Stûv Grey	230€	230€
Stûv Black	230€	230€
Inox	362€	-

## Stûv 30-compact in devantures & cheminées à poser | frontpanelen & plaatsklare schouwen

modèle étroit small model		modèle large brede model		modèles asymétriques asymmetrische modellen		cheminée de coin hoekschouw	chariot à bûches houtblokkenkarretje	Plaque de sol vloerplaat
A	B	A	B	A	B		40 × 34 × 129 Stûv Grey	Stûv Grey
843€	1 114€	1 107€	1 763€	975€	1 554€	859€	313€ <sup>(1)</sup>	99€

A: devanture | A: frontpanel

B: cheminée à poser | B: plaatsklare schouw

finition: disponibles en 20 couleurs | afwerking: beschikbaar in 20 kleuren

foyer non compris | haard niet inbegrepen

(1) disponible en StûvGrey ou StûvBlack | beschikbaar in StûvGrey en StûvBlack



**Mobilibox**

431€



**chariot à bûches  
houtblokkenkarretje**

40 × 34 × 129  
Stûv Grey 313€

50 × 34 × 129  
Stûv Grey 331€



**kit barbecue\*  
barbecue kit\***

230€



**ventilateur  
ventilator**

Stûv 16: 701€

Stûv 21: 592€ /690€ /725€

Stûv 22: 618€

Stûv microMega: 727€

Stûv 30-compactin: 689€

Stûv 30-in: 690€

\* disponible pour tous les foyers sauf pour les... | beschikbaar voor alle haarden behalve...  
... Stûv 16-in, Stûv 16-up, Stûv 16-H, Stûv 16-cube, Stûv 30-compact one



**Buse acier 2mm  
Staal kachelpijp 2mm**

Ø 150 mm L. 2m: 230 €

Ø 180 mm L. 2m: 230 €

Ø 200 mm L. 2m: 261 €

Ø 250 mm L. 2m: 494 €

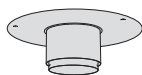

**Raccord plafond symétrique  
Symmetrische  
plafondaansluiting**

101€

145€

151€

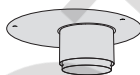

**Raccord plafond asymétrique  
Asymmetrische  
plafondaansluiting**

101€

145€

151€



**Adaptateur flexible  
Flexibele adaptor**

56€

61€

66€

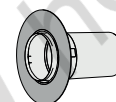



**Raccord mural  
Muuraansluiting**

89€

95€

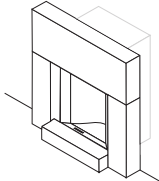
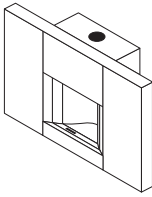
111€

			
insert <b>A*</b> inbouwhaard <b>A*</b>	devanture étroite smalle bekleding	cheminée à poser plaatsklare schouw	chariot à bûches -52cm houtblokkenkarretje -52cm
5 088€	968€ <sup>(a)</sup> 1 288€ <sup>(b)</sup>	2 283€	368€

(a) devanture sans socle –(b) devanture avec socle | (a) bekleding zonder sokkel –(b) bekleding met sokkel

Stûv microMega armoires |kasten

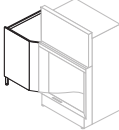
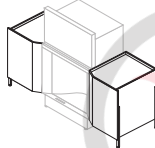
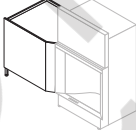
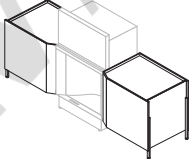
			
armoires étroites   <b>smalle kasten</b>   50cm		armoires larges   <b>brede kasten</b>   80 cm	
simple   <b>enkel</b>	double   <b>dubbel</b>	simple   <b>enkel</b>	double   <b>dubbel</b>
602€	1 203€	699€	1 398€

foyer non compris | **haard niet inbegrepen**

Stûv microMega finitions |afwerkingen

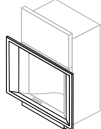
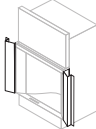
		
cadre fin   <b>fijn kader</b>	cadre appliqué   <b>opbouw kader</b>	joues métal   <b>stalen afwerkingslat</b>
368€	368€	56€ /pce   <b>stuk</b>

foyer non compris | **haard niet inbegrepen**

**PRIX PUBLICS CONSEILLÉS HTVA | AANBEVOLEN PUBLIEKE PRIJZEN EXCL. BTW. | 2022/2023|BELUX**

Les prix mentionnés sont valables jusqu'au 31/03/2023 (sauf erreur d'impression), en Belgique et au Grand-Duché de Luxembourg. Frais de transport (70€), accessoires et pose non inclus, augmentation forfaitaire incluse. Documentation et illustrations non contractuelles. **De vermelde prijzen zijn geldig t.e.m. 31/03/2023 (behalve drukfouten), in België en in het Groothertogdom Luxemburg. Transportkosten (70€), toebehoren en installatie zijn niet inbegrepen, forfaitaire verhoging inbegrepen. Niet contractueel document en illustraties.**

Éditeur responsable | Verantwoordelijke uitgever: Gérard Pitance

# TARIFS | TARIEVEN

P-10  
**stûv**

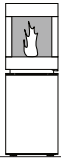

Stûv P-10 **A++**  
base courbe  
en tôle  
**gebogen onderstel  
in staal**

5 670€<sup>(1)</sup>

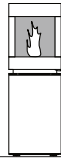

Stûv P-10 **A++**  
base rectangulaire  
en chêne foncé ou blanchi  
**recht onderstel  
in donker of gebleekt eiken**

6 242€



Stûv P-10 **A++**  
base rectangulaire  
à personnaliser  
**recht onderstel  
te personaliseren**

5 670€<sup>(1)</sup>

(1) disponibles StûvGrey et StûvBlack | beschikbaar in StûvGrey en StûvBlack

PRIX PUBLICS CONSEILLÉS HTVA | AANBEVOLEN PUBLIEKE PRIJZEN EXCL. BTW. | 2022/2023|BELUX

Les prix mentionnés sont valables jusqu'au 31/03/2023 (sauf erreur d'impression), en Belgique et au Grand-Duché de Luxembourg. Frais de transport (70€), accessoires et pose non inclus, augmentation forfaitaire incluse. Documentation et illustrations non contractuelles. De vermelde prijzen zijn geldig t.e.m. 31/03/2023 (behalve drukfouten), in België en in het Groothertogdom Luxemburg. Transportkosten (70€), toebehoren en installatie zijn niet inbegrepen, forfaitaire verhoging inbegrepen. Niet contractueel document en illustraties.

Éditeur responsable | Verantwoordelijke uitgever: Gérard Pitance